



EXTRASOFT (INDOOR + OUTDOOR)

design Piero Lissoni

Modular elements of different dimensions available for indoor and outdoor.

Indoor version: frame in double-paneled poplar and pine. Support in cross-woven coated rubber elastic straps. Padding in differentiated density polyurethane foam covered with a quilted mat in prewashed and sterilized goose down, stitched into separate compartments or, on request, padding in differentiated density polyurethane foam with a mat covered with acrylic fibre layers. Fabric or leather upholstery, both fully removable by Velcro fastenings.

Outdoor version: frame in steel lacquered for outdoor for bases and in steel lacquered for outdoor and plywood for outdoor for backrest and armrests. For bases only, support in cross-woven, coated rubber elastic straps and hooks in Stainless Steel for outdoor. Padding with open cell structure polyurethane foam DRYFEEL S, with a quilted mat in fibre for outdoor covered with waterproof fabric protection. Upholstery with outdoor fabrics only, fully removable by Velcro fastenings. Both versions are with black adjustable PVC feet. The various elements are joined together by means of hooks.
Seat depth: 68-94-120-134cm.

Notes

All elements can be ordered 5 to 10cm higher than standard.

On request, all indoor elements can be covered with the mat in acrylic fibre layers, instead of goose down.

On request can be ordered a spacer, to lift the elements of further 4cm, to be screwed to the standard feet.

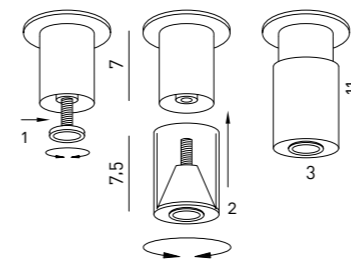

For the outdoor version it is recommended to place the elements on the floor; for placing the elements on the lawn it is recommended to use feet with spacers.

Furthermore, especially after rain or during period of high humidity, it is recommended to periodically separate the different elements and / or to temporarily lift the seat / backrest / armrest cushions to allow a complete drying of the same and to avoid the accumulation of dirt and humidity that might cause mildew. To improve the life of the product, it is also recommended to protect it with the "Outdoor Covering"; remember that this covering is water vapour repellent and prevents mould and corrosion. It can be washed with water and soap.

For 146cm and 172cm armrests and backrests with upholstery in floral, textured or velvet fabrics or in leather, there is always a central stitching.

The various elements are joined together by means of hooks, as per the instructions supplied with the product.

Hooks for assembly elements with standard feet in PVC.

Hooks for assembly elements with feet with spacers.

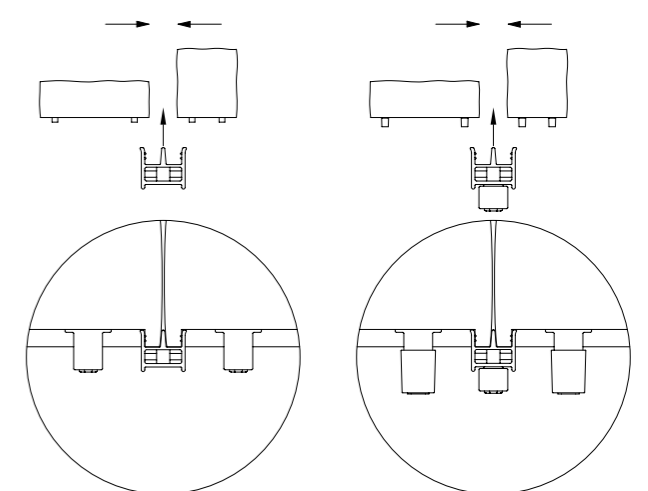

For composition with different elements, please attach a general sketch to the order.

Technical Drawings

Base

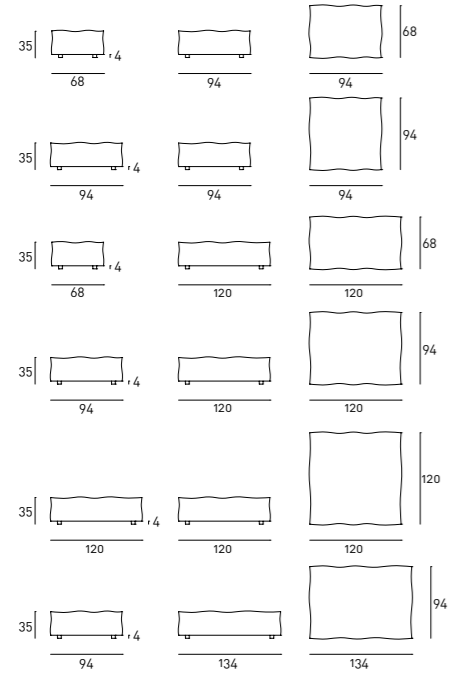

Loose Cushion

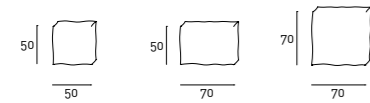

Armrest

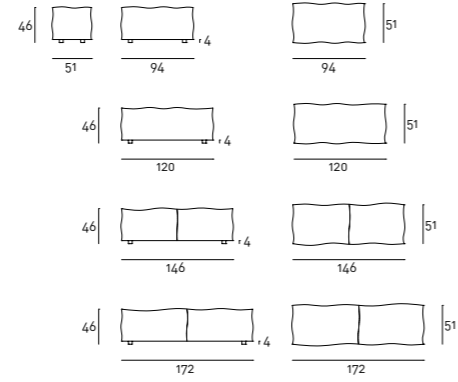

Backrest

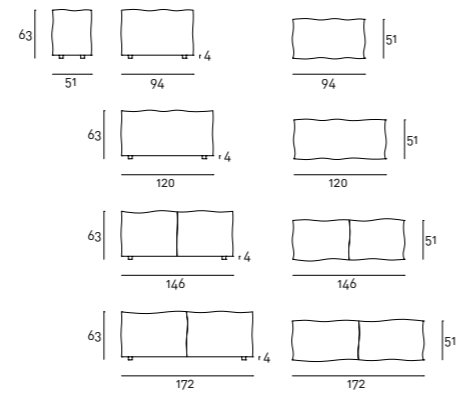

Examples of Composition

Composition 01

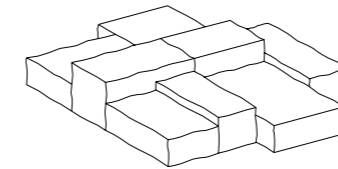
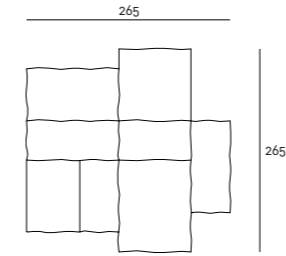

ESOE068
ESOE994
ESOE968
ESOE094

ESOB120A
ESOB094A
ESOB094B
ESOB120B

Composition 03

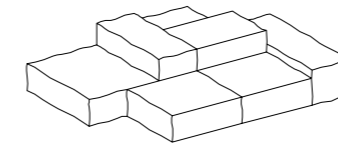
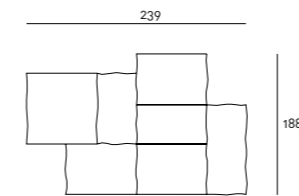

ESOE994
ESOE968
ESOE968
ESOE968

ESOB094A
ESOB094A
ESOB120B

Composition 02

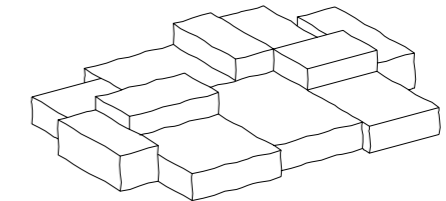
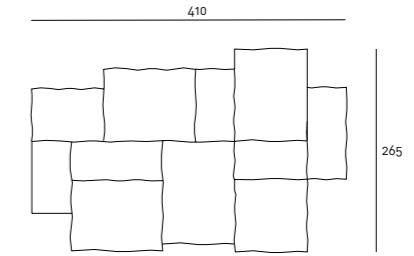

ESOE968
ESOE094
ESOE094
ESOE094
ESOE134
ESOE994

ESOB094B
ESOB120A
ESOB094A
ESOB094A
ESOB120B

Composition 04

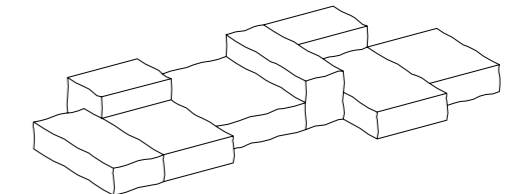
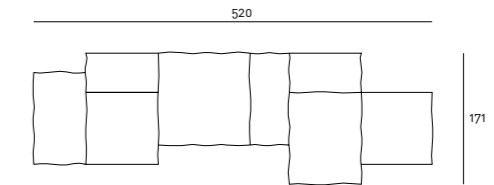

ESOE068
ESOE994
ESOE120
ESOE094

ESOE994
ESOB094A
ESOB120A
ESOB094A

The commercial codes refer to the elements chosen in the above-proposed compositions.



