



## CHEMISE - CHEMISE XL

design Piero Lissoni

Fix or modular sofa and armchair with supporting frame in lacquered drawn tubular steel. Seat frame in fir wood, with crosswoven, coated rubber elastic straps. Backrest and armrest frames made with a structural elastic material.

Shell covering in 100% polyether thermally bonded onto a polyamide velveteen backing. Seat cushions padded with polyurethane foam and coated with prewashed and sterilized goose down, stitched into separate compartments or polyurethane covered with acrylic fibre layers. Backrest cushions with polyurethane foam coated with prewashed and sterilized goose down, stitched into separate compartments. The coverings of the backrest and seat cushions are joined together by zippers.

Loose cushions in prewashed and sterilized goose down, stitched into separate compartments.

Tubular feet in AISI 304 Stainless Steel with matt satin-finish or, on request, available in natural or ebony-dyed oak. Fabric or leather upholstery, both fully removable by zippers and Velcro fastenings. Standard flounce 7 cm from the floor for fabric upholstery only, on request available also without flounce, to be confirmed on the order. Seat depth 61-81 cm.

### Feet



Stainless Steel  
with Matt Satin  
Finish



Natural Oak

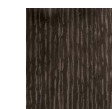

Ebony Dyed  
Oak

### Notes

The version with flounce is not available for leather and velvet upholstery.

According to the product shape, some coverings cannot be used: please refer to the adaptability sheet in the "Materials" section of the website.

For leather coverings the "Leather A" or "Leather B" Maintenance Kit is included with the product.

For composition with different elements, please attach a general sketch to the order.

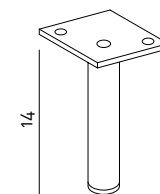

Standard foot in Stainless Steel  
AISI 304.

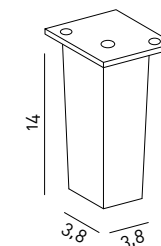

On request, foot in natural  
or ebony-dyed oak.

Technical Drawings

Armchair

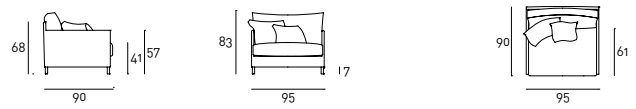

Sofa

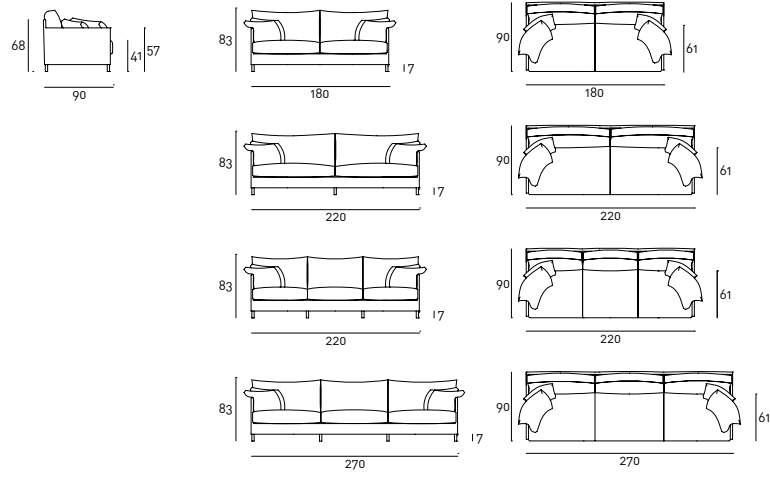

Terminal Element

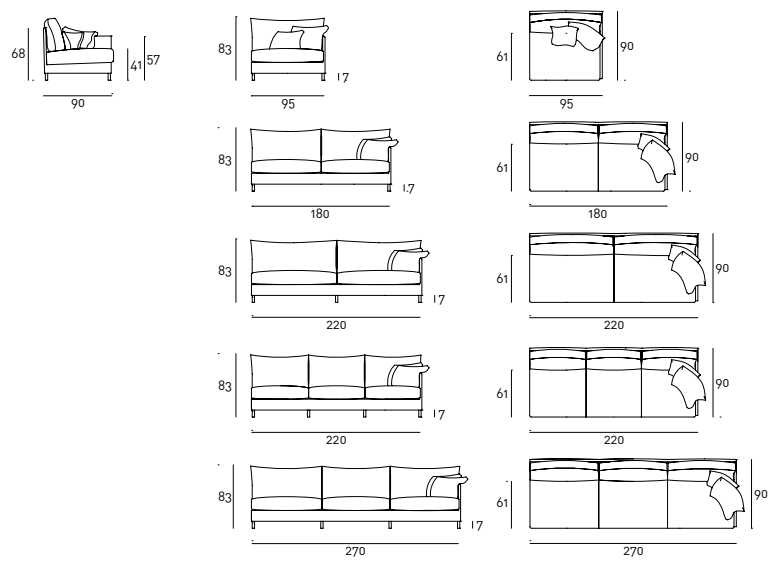

Central Element

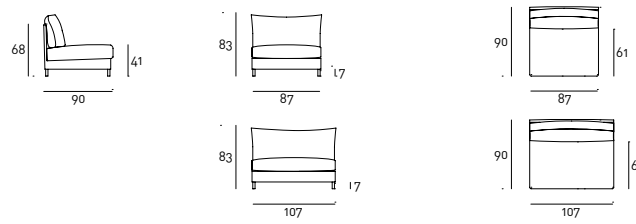

Corner Element

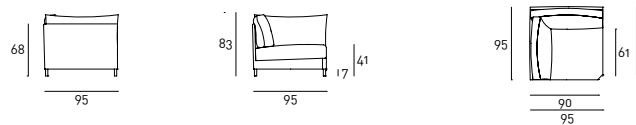

Long Seat

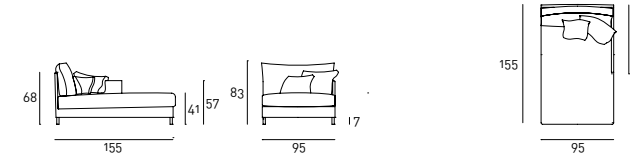

Chemise XL  
Armchair

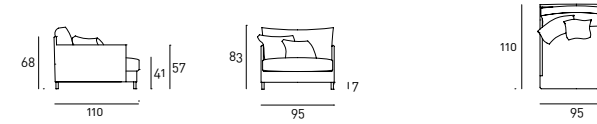

Sofa

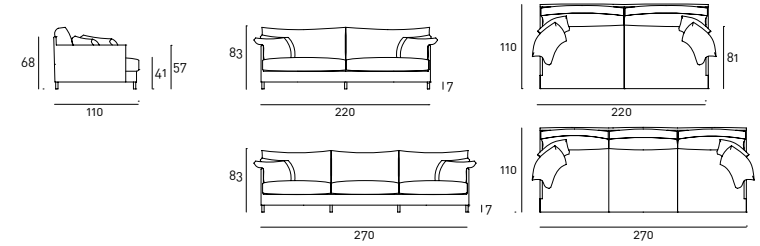

Footrest

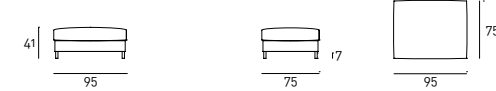

Loose Cushion

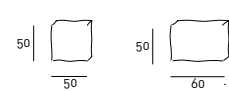

Examples of Composition

Composition 01

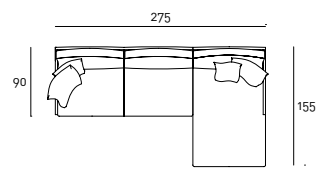

CHET180 SX  
CHES155 DX

Composition 01

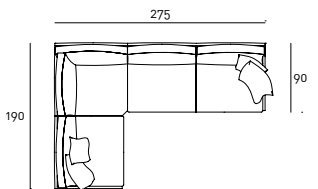

CHET095 SX  
CHEA095  
CHET180 DX

Composition 01

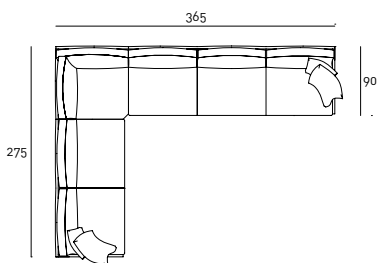

CHET180 SX  
CHEA095  
CHET270 DX

Composition 01

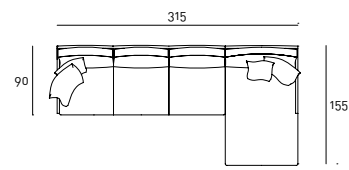

CHET223 SX  
CHES155 DX

Composition 01

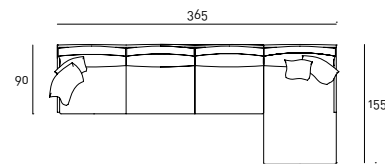

CHET270 SX  
CHES155 DX

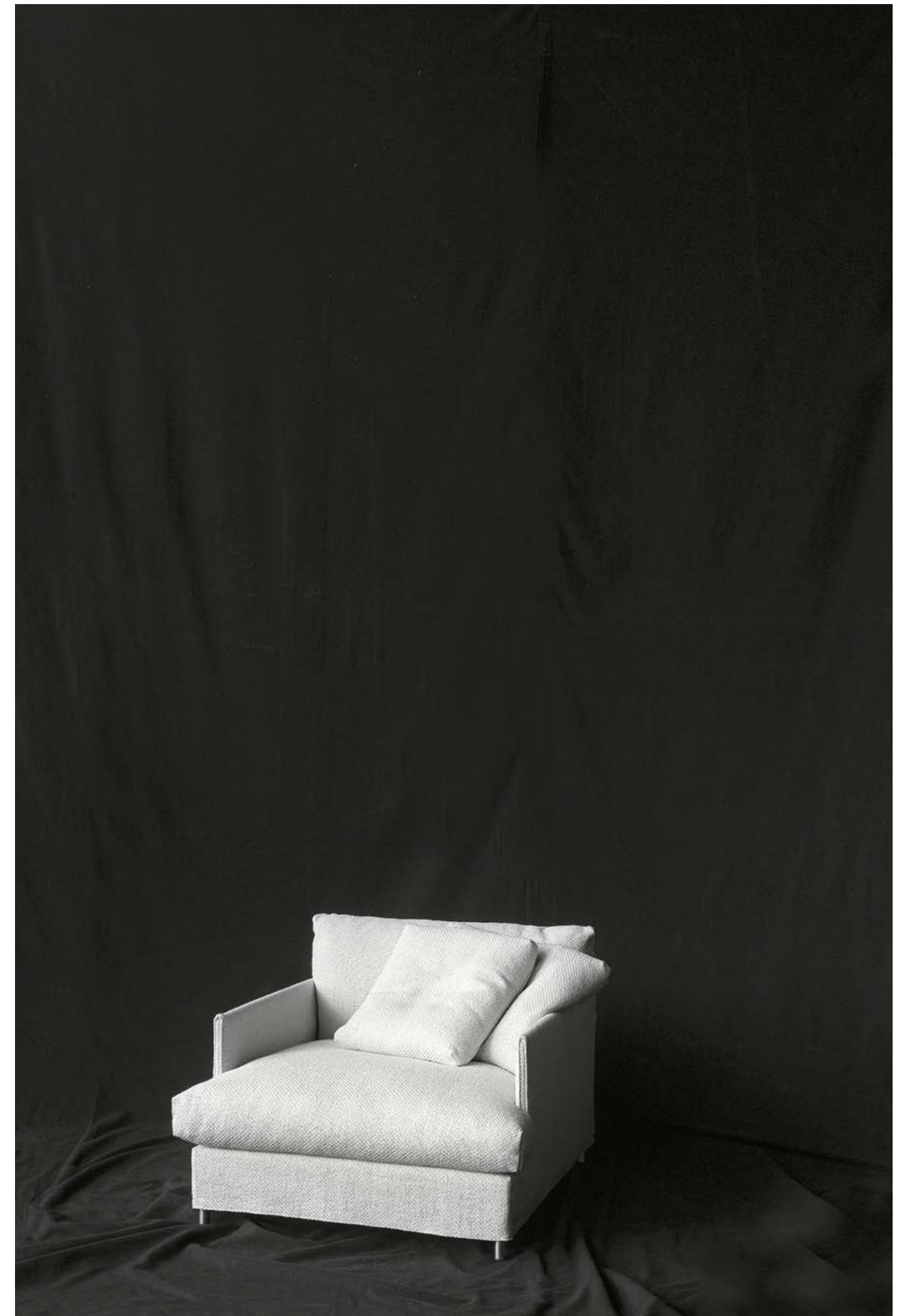

The commercial codes refer to the elements chosen in the above-proposed compositions.